

SW2 Swivel 1U Patch Panel

An innovative lightweight 1U, 19" rack mountable swivel patch panel, designed to manage up to 120 fibres. It is compatible with LC, SC and ST adaptor types. It can be loaded with up to 5 splice trays that can house up to 24 fibres each and it features integrated cable management to assure optimal patch cord routing and bend radius protection.

Features

- 1U height
- 19" rack mountable
- Up to 120 fibres with LC quad adaptors
- Comes with all necessary splice trays
- Very lightweight – ABS construction
- Integrated advanced cable management
- Available with LC, SC (both flangeless) or ST adaptors

Applications

- Data centres
- High density applications
- Telecommunication networks
- Enterprise Networks
- Central Offices

Specifications

ELEMENT	VALUE
Depth (mm)	278.2mm
Width (mm)	445.2mm
Height (mm)	43.6mm
Rack Units	1U
Adaptor Capacity	30 x LC Quad, 24 or 48 x SC Simplex, 12 or 24 x ST Simplex

Ordering Information

SC Simplex Configuration

DESCRIPTION	PART NUMBER
Datatronix SW2 Swivel Patch Panel 1U Loaded with 24 SC Simplex Multimode Beige Adaptors	PPSW2-02-21-24
Datatronix SW2 Swivel Patch Panel 1U Loaded with 24 SC Simplex Multimode OM3 Aqua Adaptors	PPSW2-02-31-24
Datatronix SW2 Swivel Patch Panel 1U Loaded with 24 SC Simplex Multimode OM4 Erika Violet Adaptors	PPSW2-02-41-24
Datatronix SW2 Swivel Patch Panel 1U Loaded with 24 SC Simplex Singlemode Blue Adaptors	PPSW2-02-91-24
Datatronix SW2 Swivel Patch Panel 1U Loaded with 24 SC Simplex Singlemode APC Green Adaptors	PPSW2-03-91-24
Datatronix SW2 Swivel Patch Panel 1U Loaded with 48 SC Simplex Multimode Beige Adaptors	PPSW2-02-21-48-V
Datatronix SW2 Swivel Patch Panel 1U Loaded with 48 SC Simplex Multimode OM3 Aqua Adaptors	PPSW2-02-31-48-V
Datatronix SW2 Swivel Patch Panel 1U Loaded with 48 SC Simplex Multimode OM4 Erika Violet Adaptors	PPSW2-02-41-48-V
Datatronix SW2 Swivel Patch Panel 1U Loaded with 48 SC Simplex Singlemode Blue Adaptors	PPSW2-02-91-48-V
Datatronix SW2 Swivel Patch Panel 1U Loaded with 48 SC Simplex Singlemode APC Green Adaptors	PPSW2-03-91-48-V

LC Quad Configuration

DESCRIPTION	PART NUMBER
Datatronix SW2 Swivel Patch Panel 1U Loaded with 30 LC Quad Multimode Beige Adaptors	PPSW2-00-24-30
Datatronix SW2 Swivel Patch Panel 1U Loaded with 30 LC Quad Multimode OM3 Aqua Adaptors	PPSW2-00-34-30
Datatronix SW2 Swivel Patch Panel 1U Loaded with 30 LC Quad Multimode OM4 Erika Violet Adaptors	PPSW2-00-44-30
Datatronix SW2 Swivel Patch Panel 1U Loaded with 30 LC Quad Singlemode Blue Adaptors	PPSW2-00-94-30
Datatronix SW2 Swivel Patch Panel 1U Loaded with 30 LC Quad Singlemode APC Green Adaptors	PPSW2-01-94-30

ST Configuration

DESCRIPTION	PART NUMBER
Datatronix SW2 Swivel Patch Panel 1U Loaded with 12 ST Simplex Multimode Adaptors	PPSW2-04-21-12
Datatronix SW2 Swivel Patch Panel 1U Loaded with 12 ST Simplex Singlemode Adaptors	PPSW2-04-91-12
Datatronix SW2 Swivel Patch Panel 1U Loaded with 24 ST Simplex Multimode Adaptors	PPSW2-04-21-24-V
Datatronix SW2 Swivel Patch Panel 1U Loaded with 24 ST Simplex Singlemode Adaptors	PPSW2-04-91-24-V

Technical Drawing

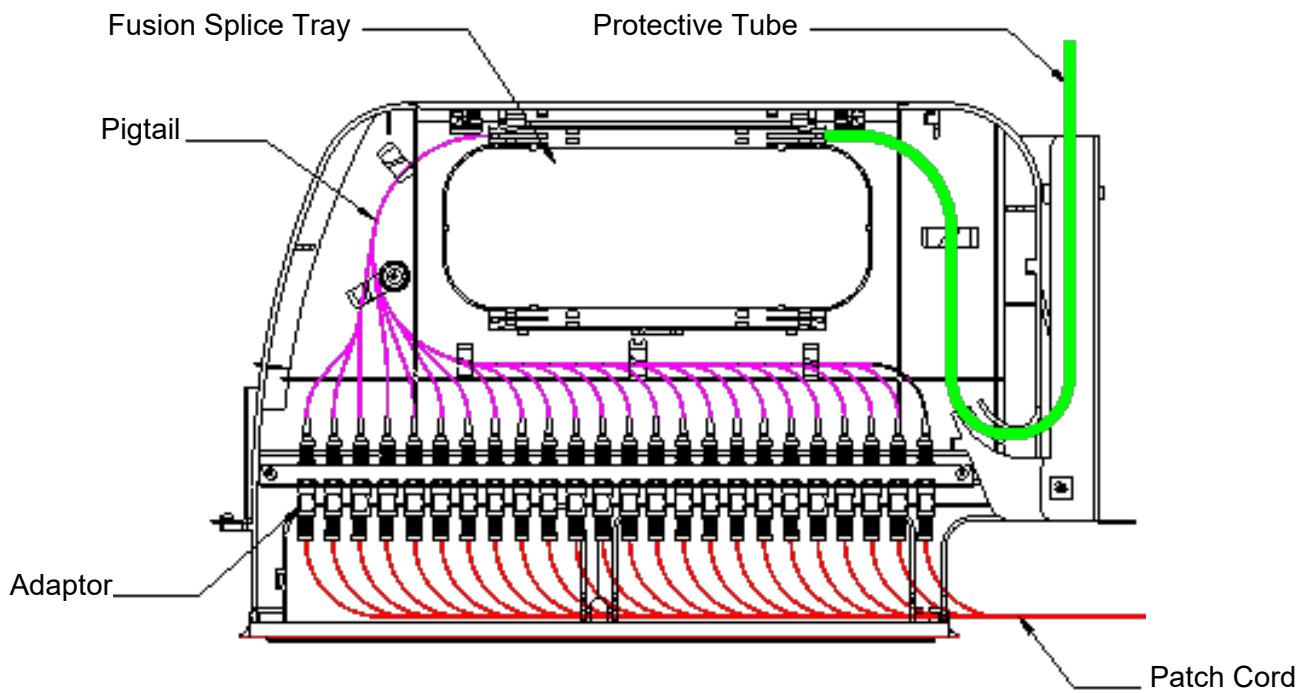
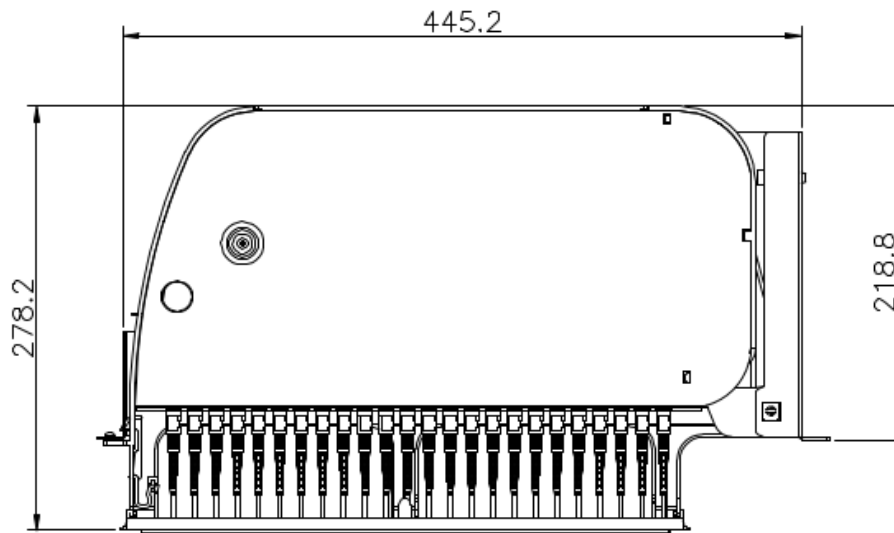
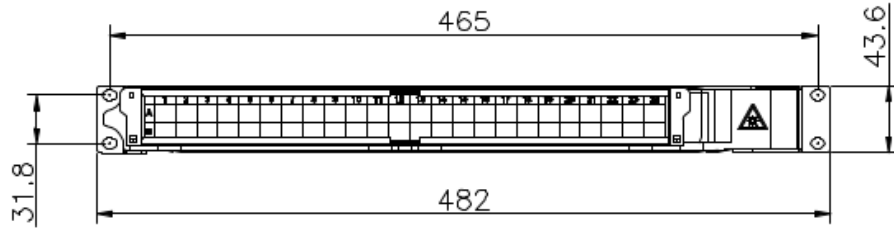

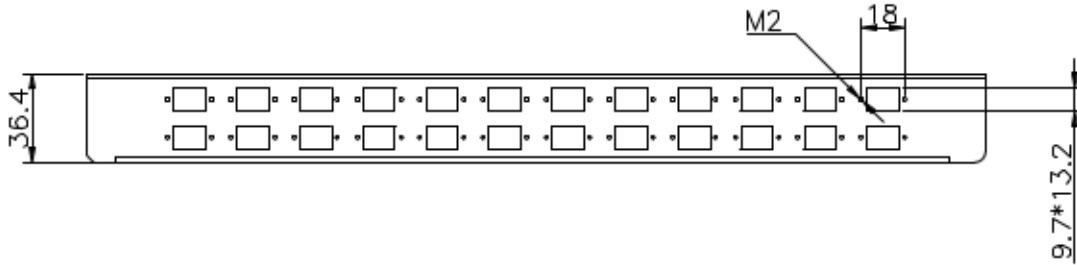

24 Port for SC Simplex Adaptor

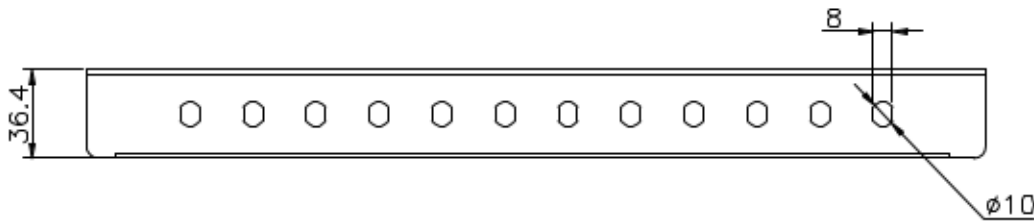

12 Port for ST Simplex Adaptor

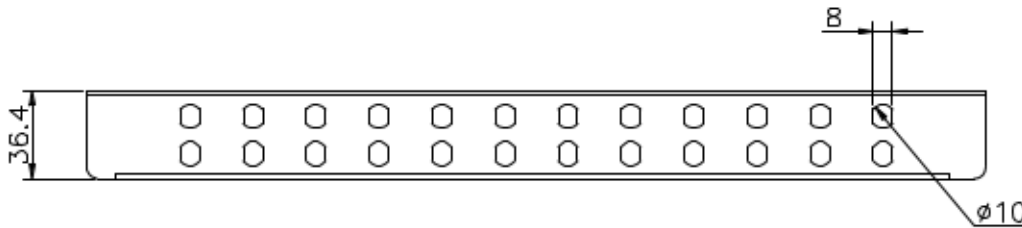

24 Port for ST Simplex Adaptor

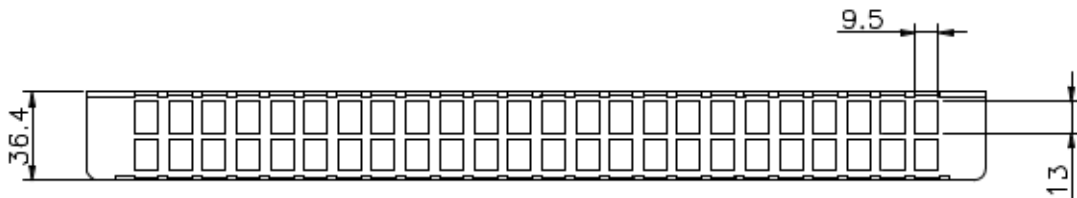

48 Port for SC Simplex Adaptor

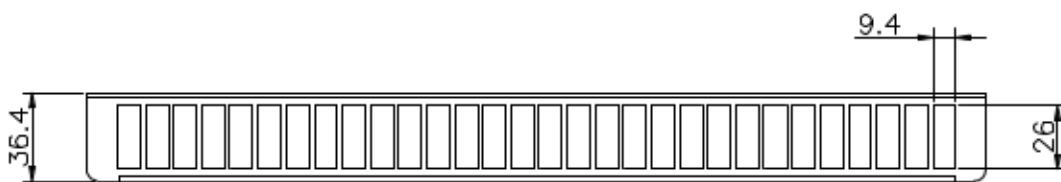

30 Port for LC Quad Adaptor

Additional Images

